

ALBED

M I L A N O 1 9 6 4

TECHNICAL BOOK

Bookcase

LINE

PRODUCT'S CARD N° LN1

Product and legal denomination: Bookcase
Commercial name: LINE

Typology: ALUMINIUM WOOD AND GLASS

PRODUCTS' COMPONENTS	USED MATERIALS
METAL PARTS	Profile in profiled aluminium uni 3569.
GLASS PARTS	Stratified glass 3+3 uni en 572-1 uni en 572-2 uni en 12543. Finishing: lacquered.
CONTAINERS	Structure made up of panels derived from wood.
GASKETS AND OTHER ACCESSORIES	Hinge: steel or zama.
POSSIBLE HARMFUL SUBSTANCES TO HEALTH	None.
ORDINARY MAINTENANCE	Clean with a soft cloth, slightly dampened and free from products containing solvent and/or abrasive material.
WARNINGS	The assembly must be made only by expert people.

These cards of certification of the product comply with all what the law n.206 del 06.09.2005 prescribes.

DELMONTE S.R.L IS CERTIFIED WITH THE MANAGEMENT SYSTEM FOR THE QUALITY ACCORDING TO UNI EN ISO 9001:2000, FOR THE ACTIVITY OF PLANNING AND PRODUCTION OF DOORS FOR INTERIORS, FURNISHINGS AND COMPLEMENTS FURNITURE IN ALUMINIUM.



STRUCTURE (TOP AND BOTTOM, SIDES, SHELVES AND VERTICAL PARTITIONS)

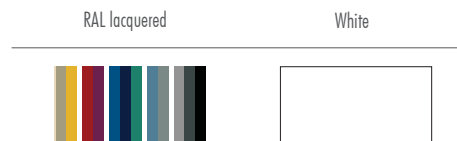

COMPONENTS AND BACKS

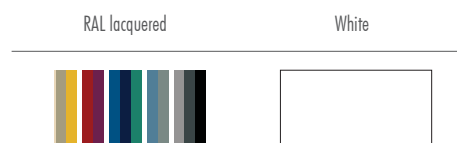

BACKS IN GLASS

Glasses:

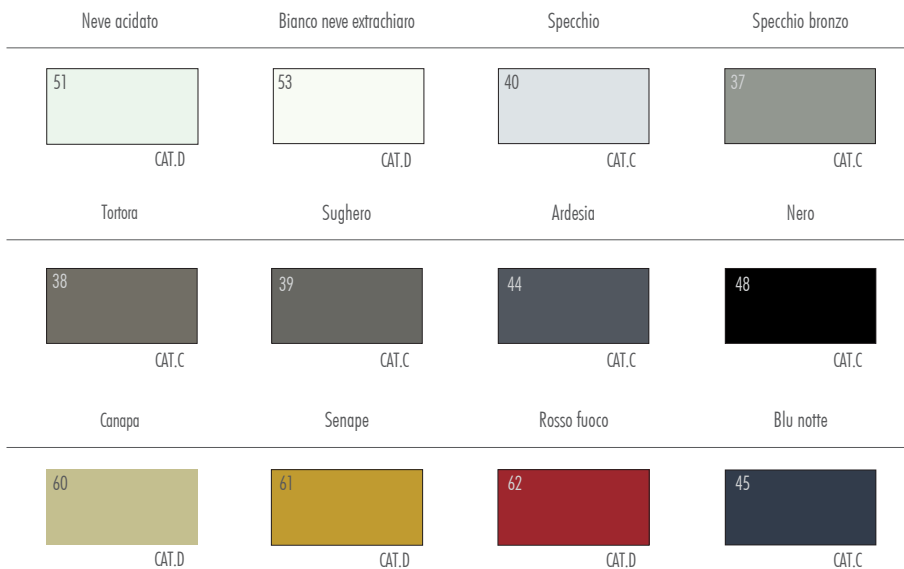

BOOKCASE LINE

COMPONENTS' LIST OF WALL SOLUTION

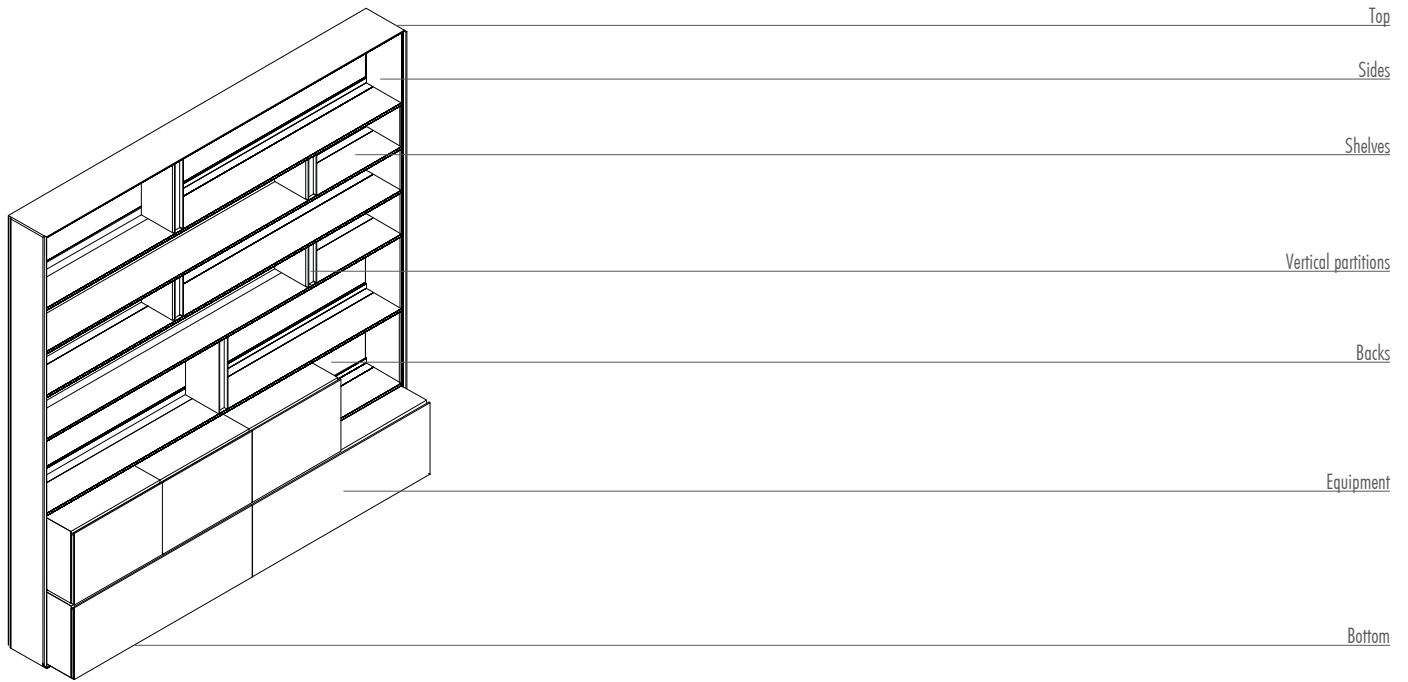

MODULES DIMENSIONS

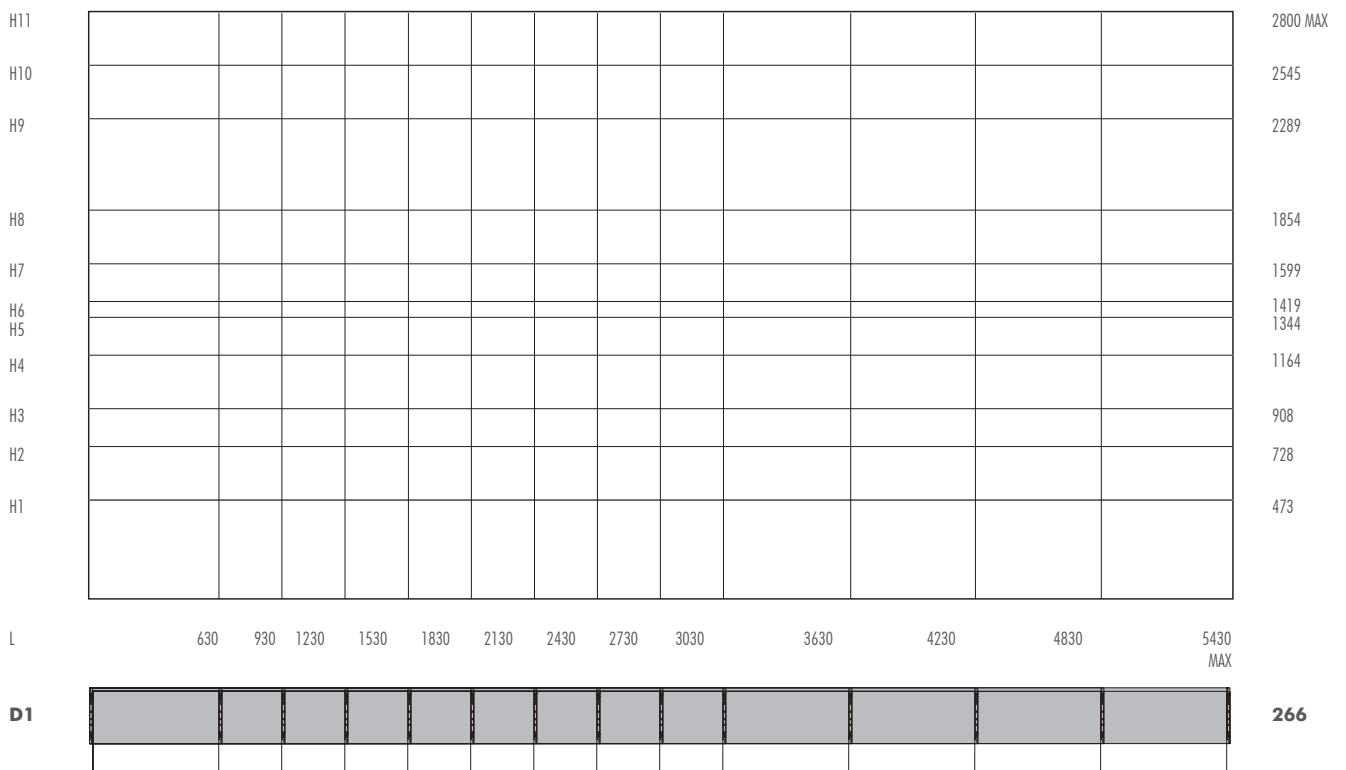

VERTICAL PARTITIONS POSITIONING

The maximal width of the modules can't be more than 1500 mm

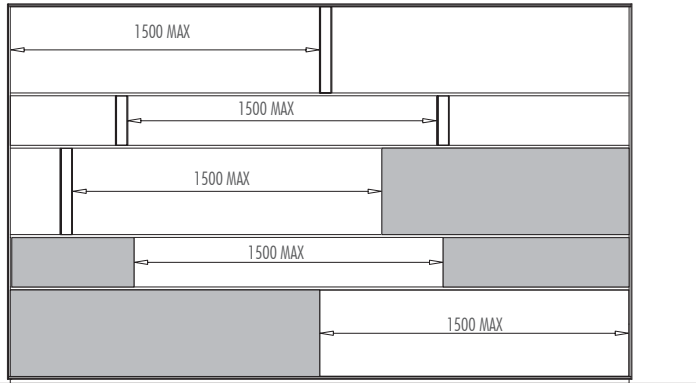

CENTRE TO CENTRE DISTANCE EQUIPMENT POSITION

ASSEMBLING SEQUENCE

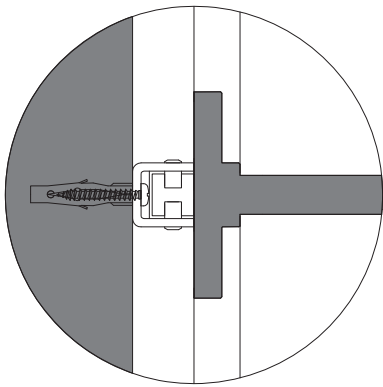

DETAIL OF THE ADJUSTABLE FEET

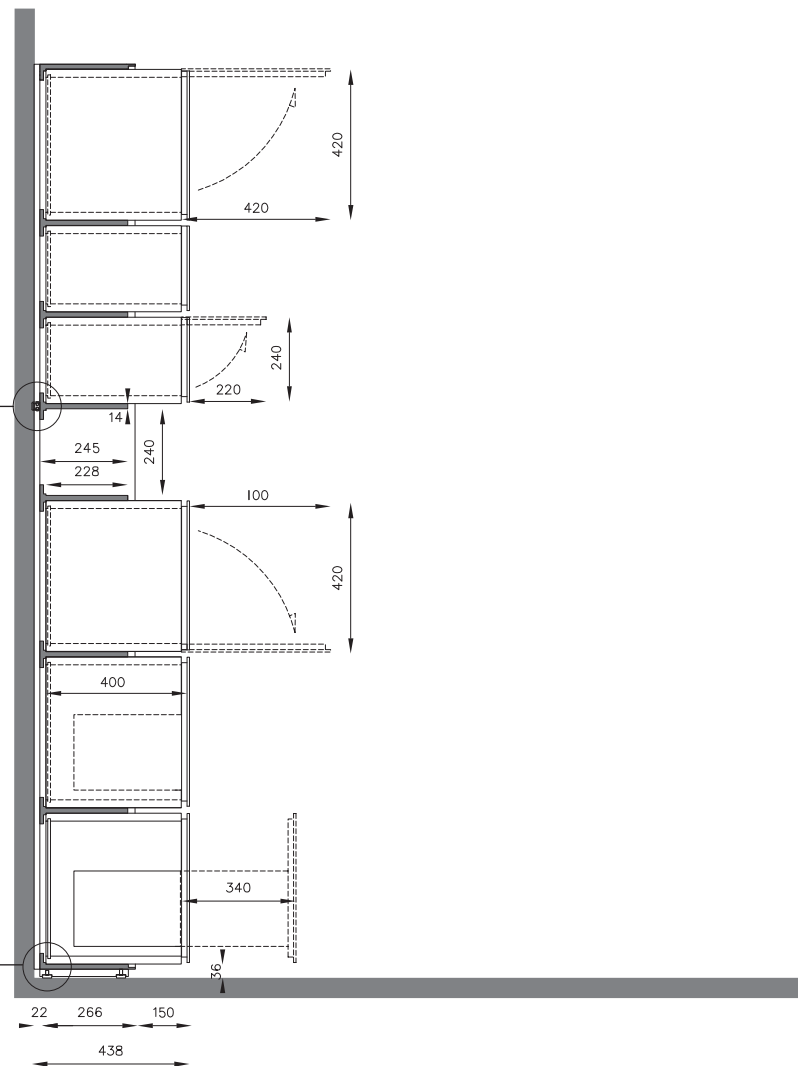
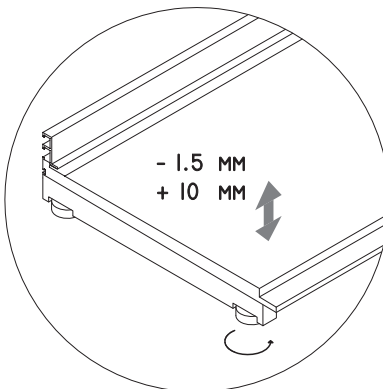

BOOKCASE COMPONENTS

TOP AND BOTTOM

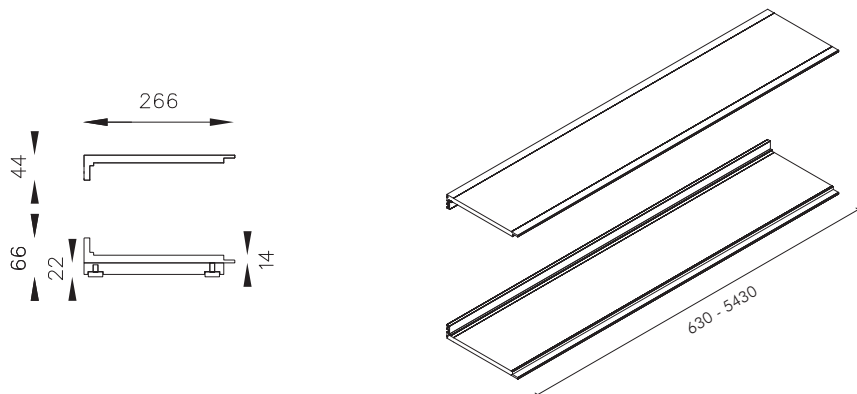

SIDES

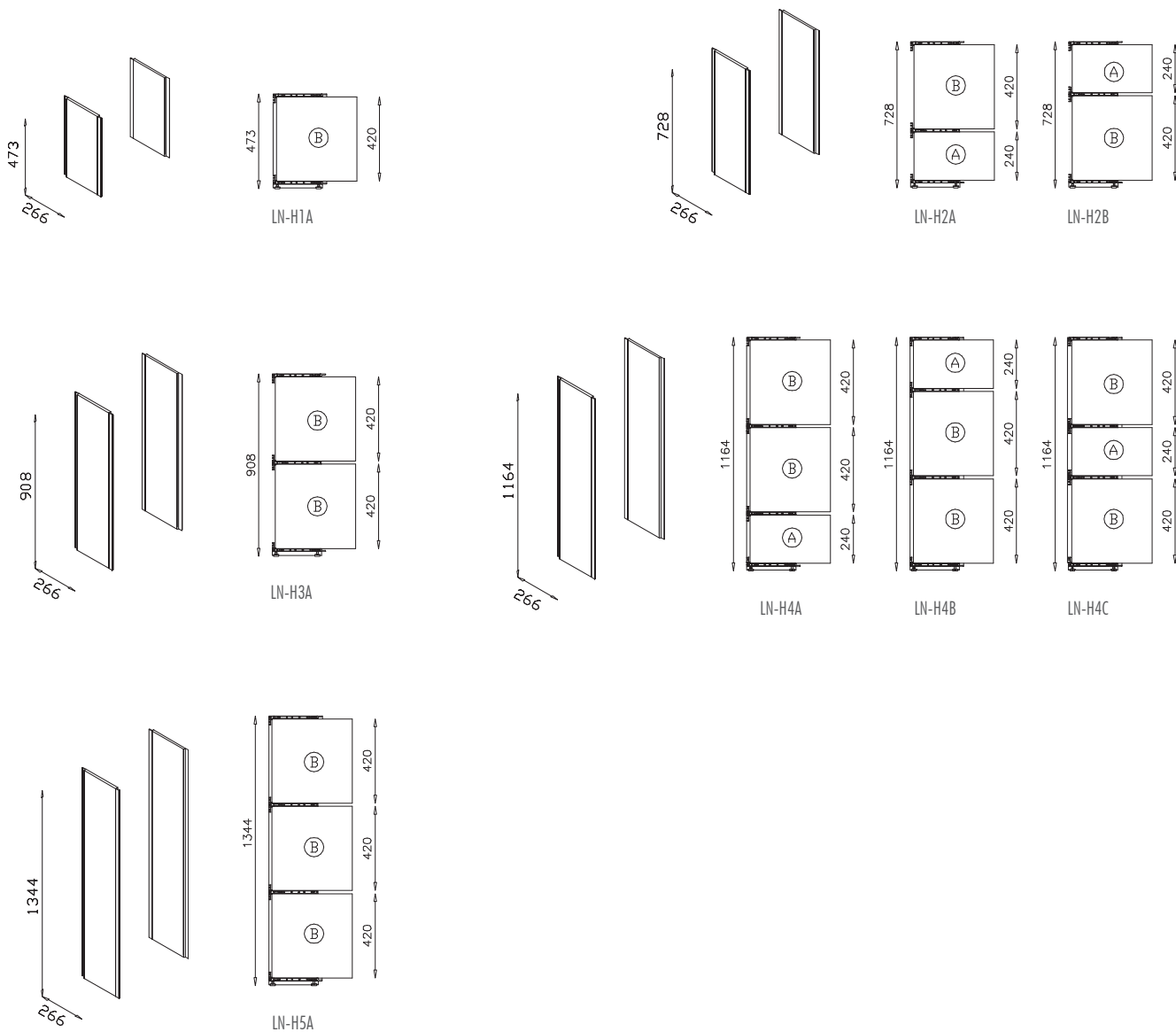

SIDES

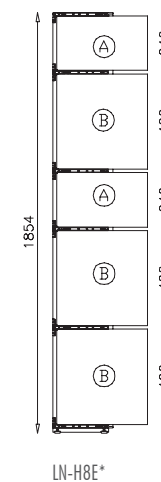
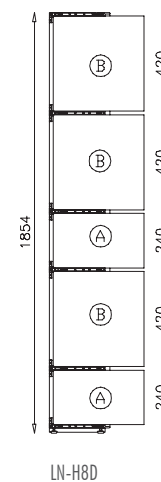
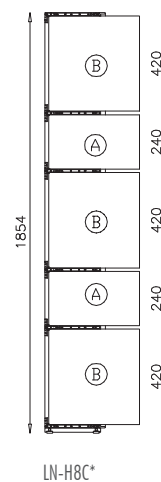
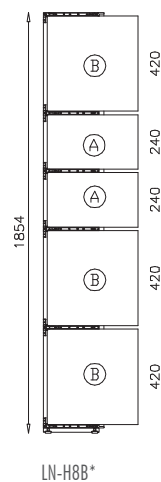
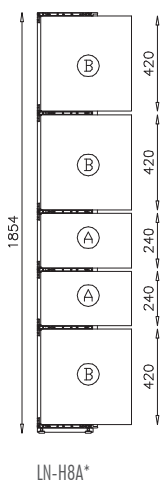
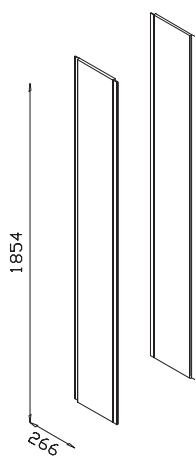
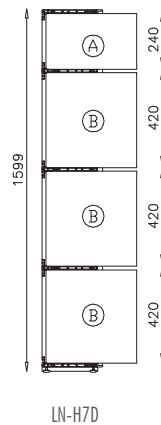
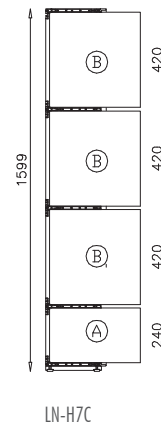
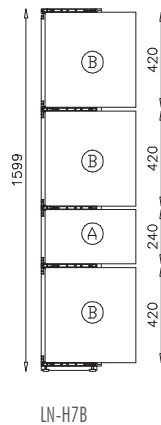
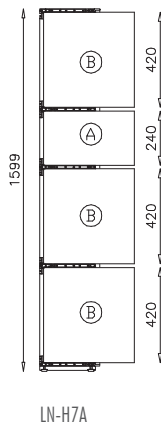
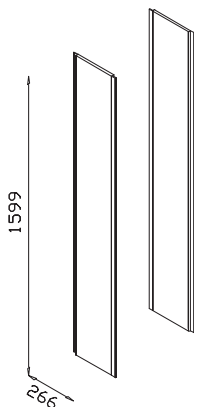
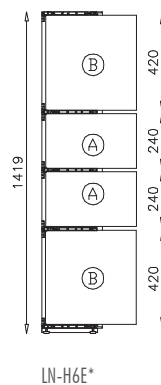
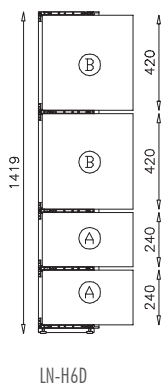
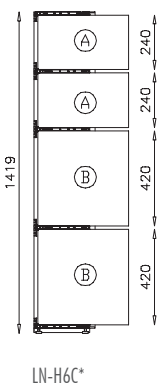
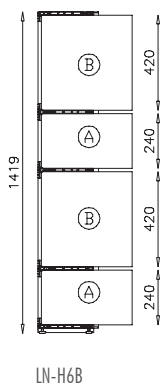
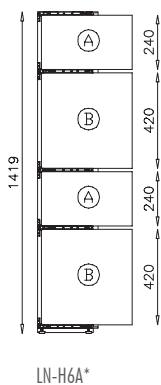
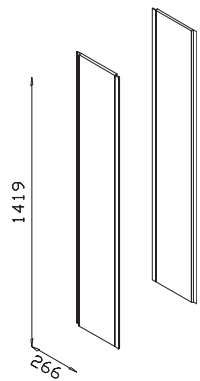

BOOKCASE COMPONENTS

SIDES

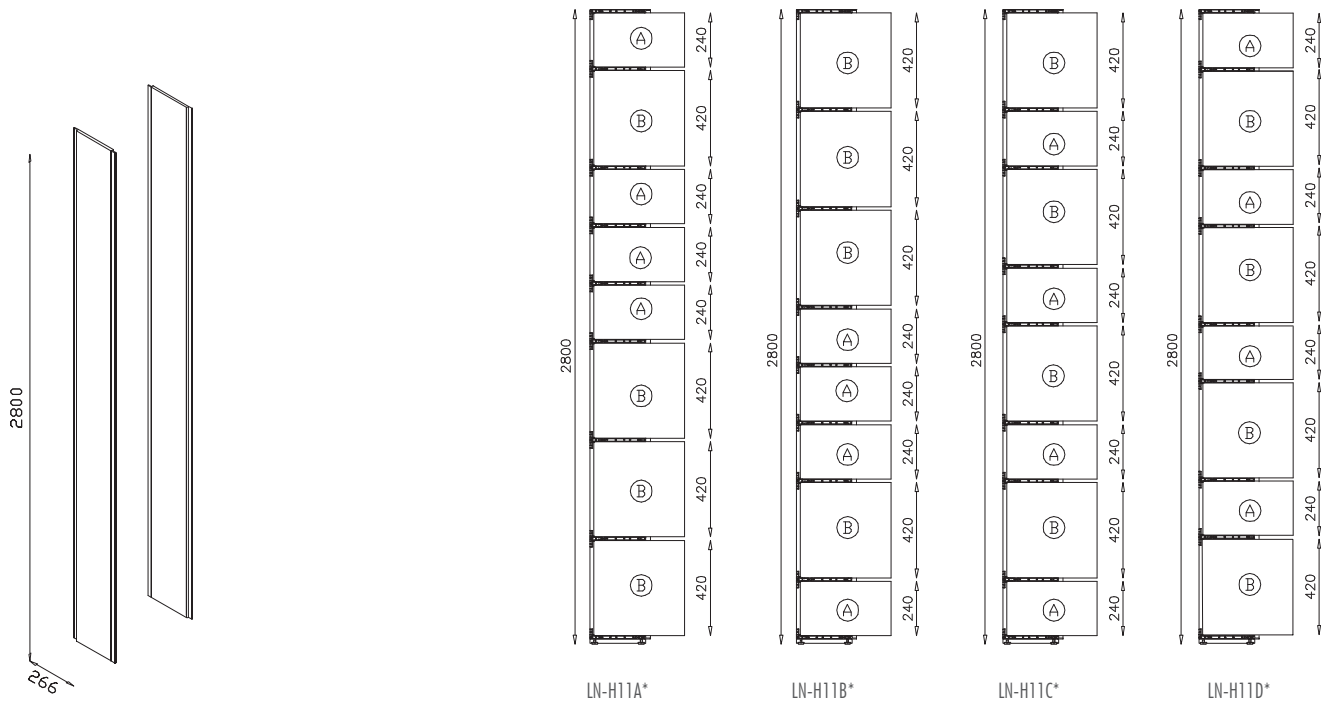
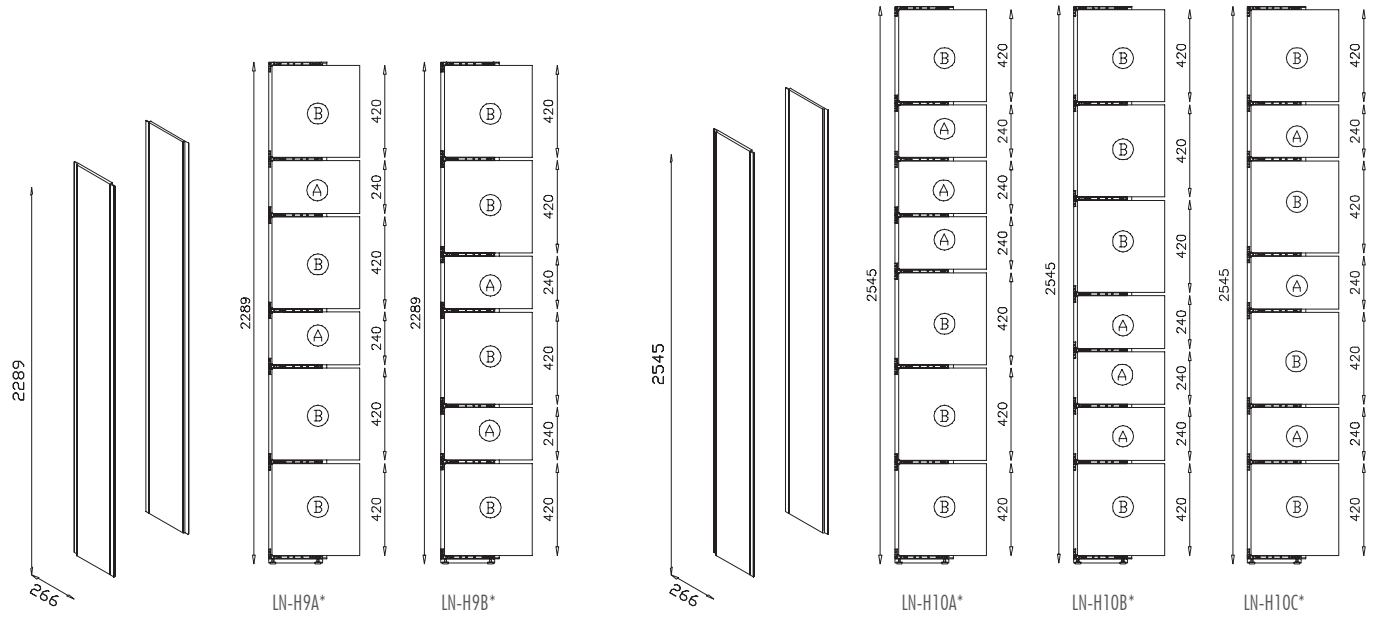

SHELVES

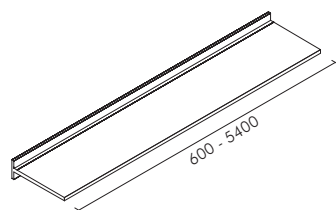
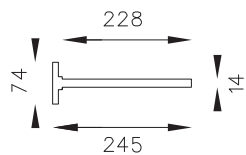

VERTICAL PARTITIONS

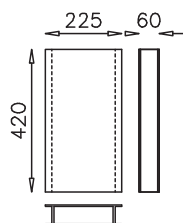
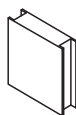
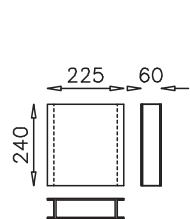

BACKS

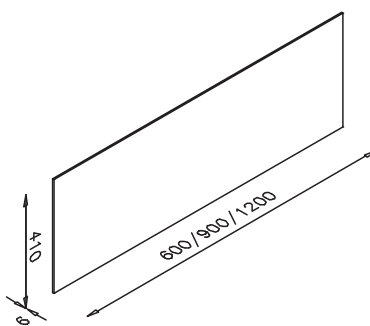
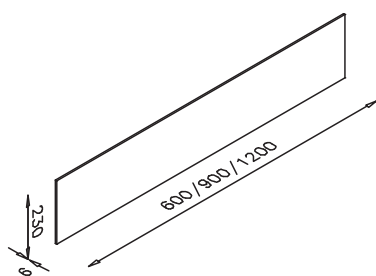

BOOKCASE TV SYSTEM

MODULE A

Pair of vertical partitions for TV system to be installed in the following combinations:

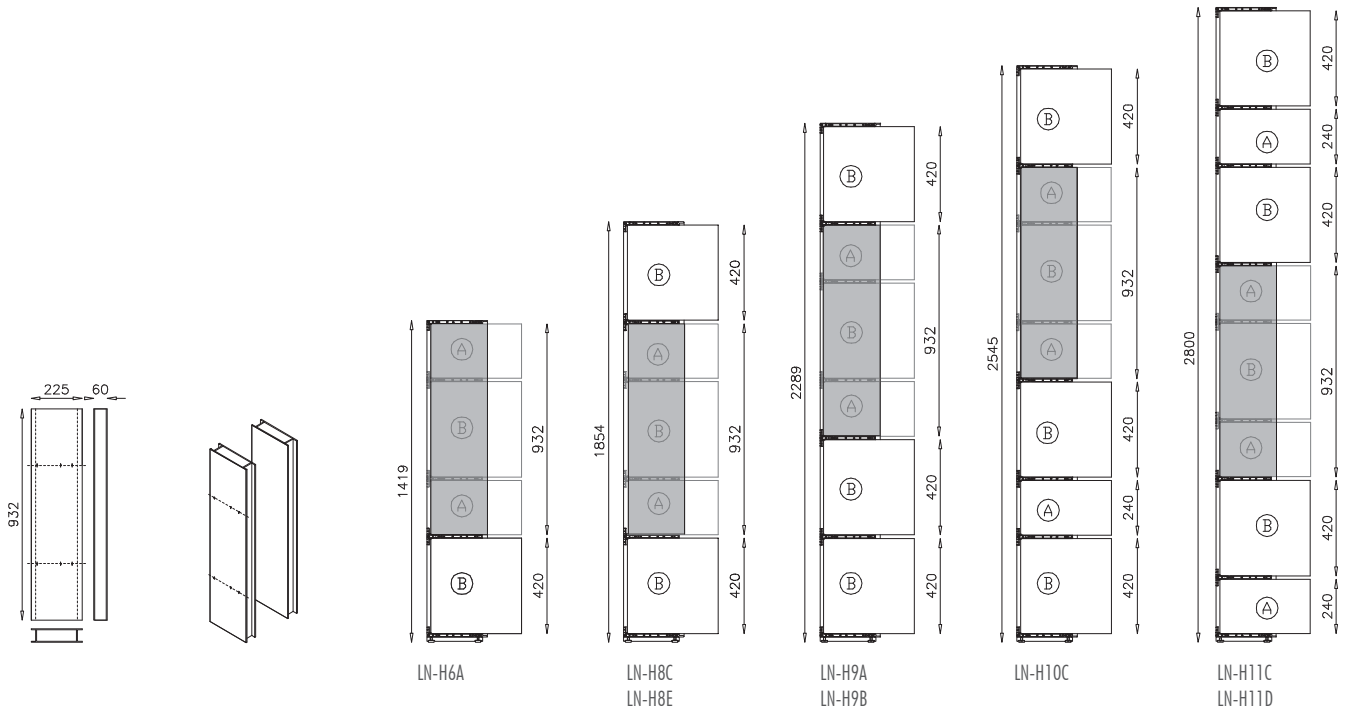

MODULE B

Pair of vertical partitions for TV system to be installed in the following combinations:

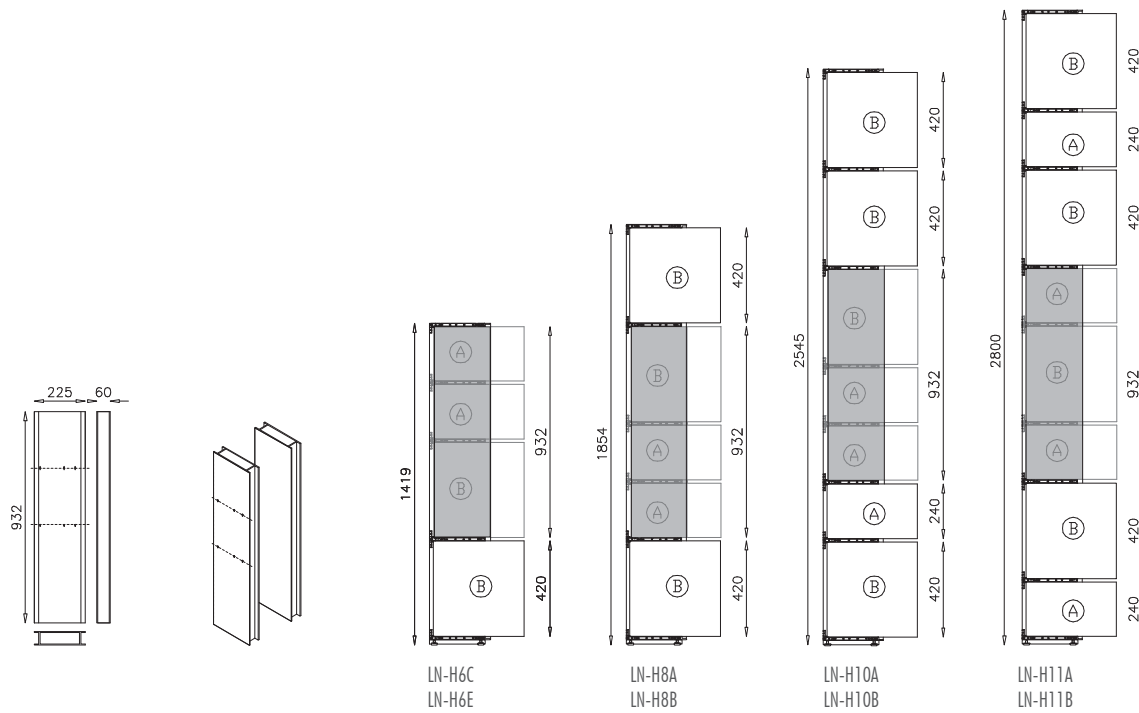

INDICATIONS FOR TV SYSTEM

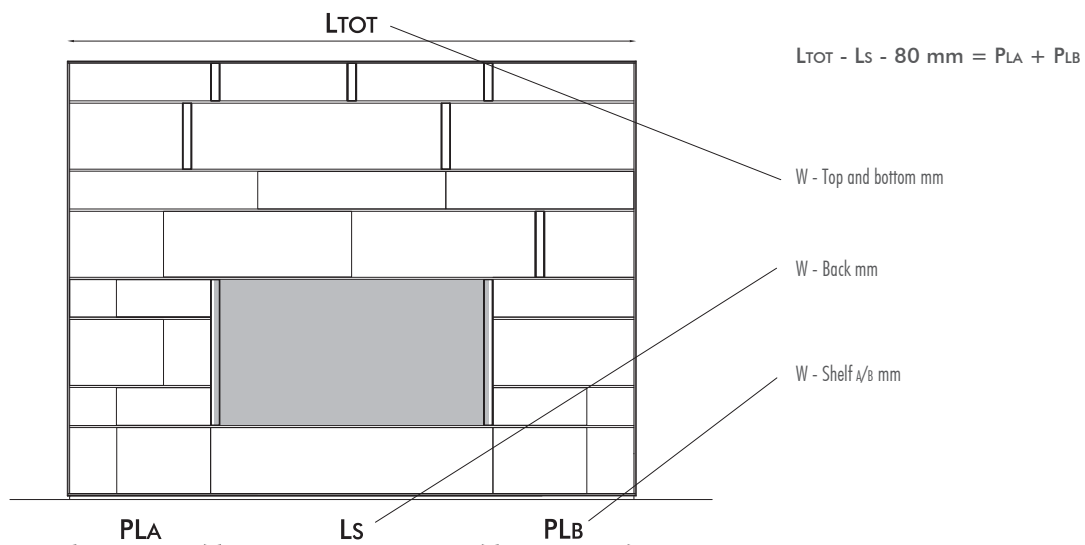

BACK FOR TV SYSTEM

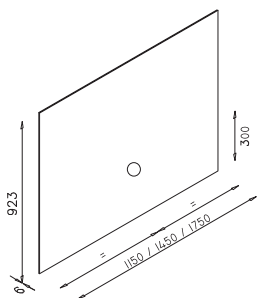

BOOKCASE EQUIPMENT

DRAWER UNIT

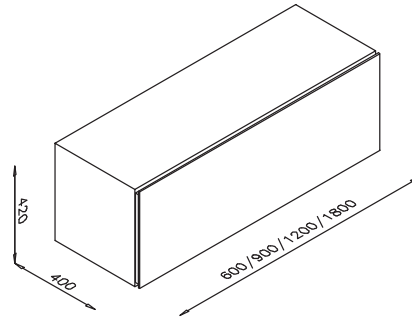
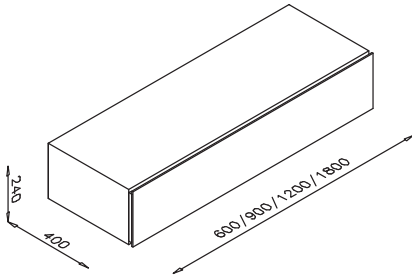

FLAP DOWN DOOR

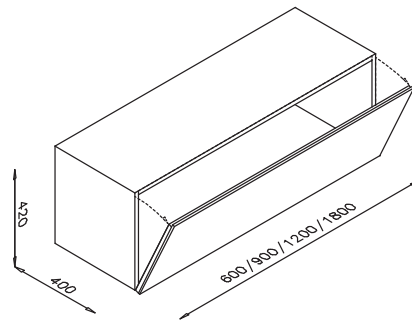
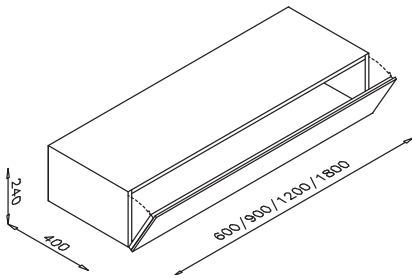

FLAP TO RISE DOOR

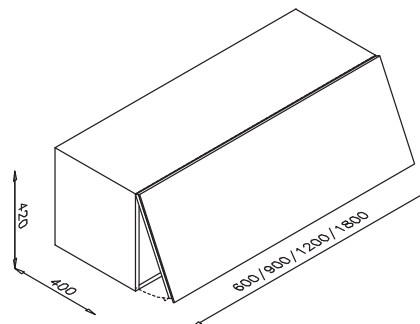
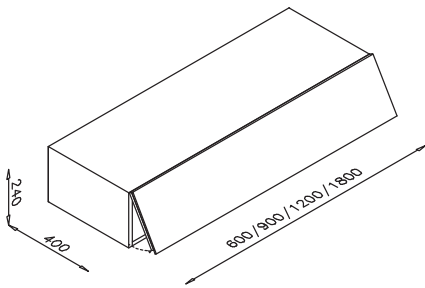

BOX SOUND

